

# Scandvik Lighting Catalog 2018



# 4 COLOR LED

A2.5 weather proof down lights are able to display your choice of White, Blue, Red or Green with no special switches, wires or controllers. Auto cycling 2-wire down lights. Switch light off and on again within 1.5 seconds to cycle through each of the four colors. Turning the light off for more than 5 seconds resets the light to White. Made of rugged stainless steel with IP67 protection, this light is easily suitable for overhead interior ceilings or exterior locations in T-tops, hard tops, flybridge or covered decks. Installation requires no special tools, strong stainless steel spring clips hold light firmly in place in a 2" diameter mounting hole.

### #41416P A2.5 4-COLOR Down Light

- Auto cycling: Daylight White/Blue/Red/Green
- 2" Mounting Hole, Flush/Spring Clip Mount
- Switch OFF/ON within 1.5 seconds to select color
- Auto resets to White when turned off
- Daylight White (5500-6300K) / 286 Lumens
- 12/24 V - 2.6 W
- IP67
- 316 Stainless Steel

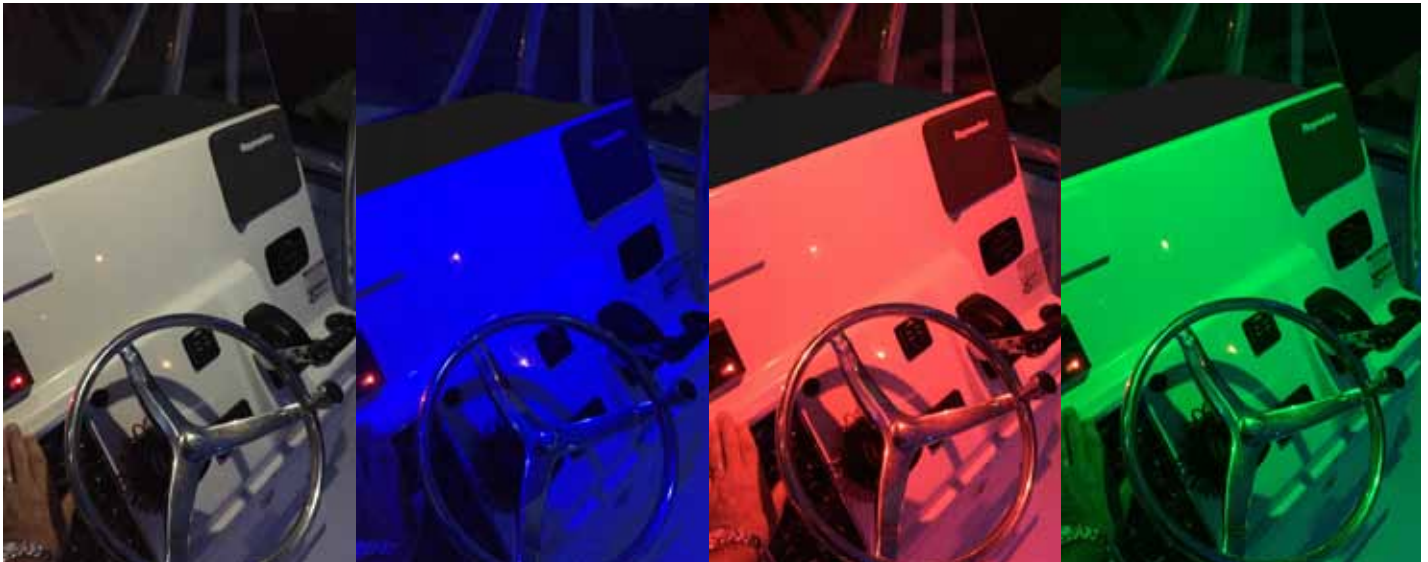
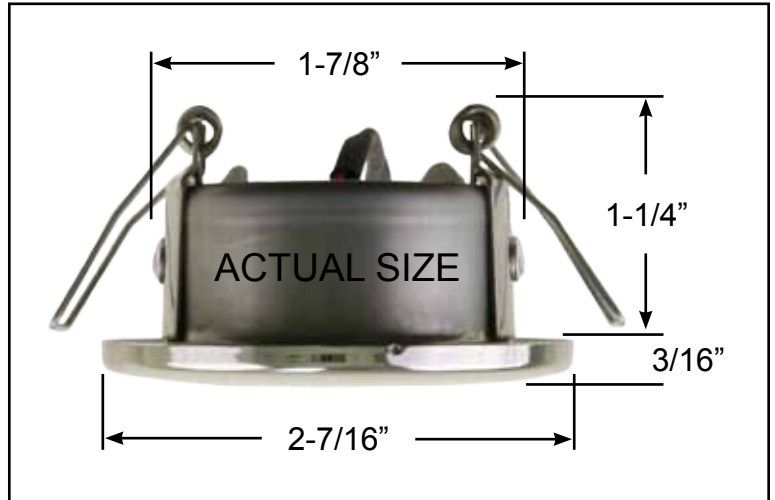

# LED Ceiling Lights

## A3



Stainless Steel Trim



White Plastic Trim



Stainless Steel Trim

Other Trim Rings Available:  
 - Round Brass  
 - Square 316 Stainless Steel

### 3" LED Ceiling Light

- Dimmable -- with any Pulse-Width Modulation Dimmer
- Polycarbonate Lens

#### Warm White LED

- 6 x 0.5 Watt Warm White LED
- 242 Lumens
- 12 V - 2.2 W

**#41368P** Flush Mount, 316 Stainless Steel Trim

**#41379P** Flush Mount, White Trim

**#41317P** Surface Mount, White Trim

**#41373P** Surface Mount, 316 Stainless Steel Trim

**#41393P** Flush Mount, Black Trim

#### Cool white LED

- 6 x 0.5 Watt Cool White LED
- 170 Lumens
- 12 V - 2.2 W

**#41420P** Flush Mount, 316 Stainless Steel Trim

**#41421P** Flush Mount, White Trim

**#41423P** Surface Mount, White Trim

**#41422P** Flush Mount, Black Trim

#### Dual Color, Warm White with Blue Night Light

- 6 x Warm White LED
- 6 x TOP Blue LED
- 12 V - (White 2.2 W) (Blue 0.45 W)
- 3-Wire

**#41376P** Flush Mount, 316 Stainless Steel Trim

**#41377P** Flush Mount, White Trim

**#41378P** Surface Mount, 316 Stainless Steel Trim

**#41394P** Flush Mount, Black Trim

- IP67
- Screw mount
- Snap-over trim ring



Black Plastic Trim



3" Plastic Trim  
2-3/4" SS Trim  
FLUSH MOUNT



3" Plastic Trim  
2-3/4" SS Trim  
SURFACE MOUNT



**#41317P** Warm White  
**#41423P** Cool White

#### Dual Color, Warm White with Red Night Light

- 6 x Warm White LED
- 6 x TOP Red LED
- 12 V - (White 2.2 W) (Red 0.45 W)
- 3-Wire

**#41386** Flush Mount, 316 Stainless Steel

**#41385** Flush Mount, White Trim

**#41387** Surface Mount, 316 Stainless Steel

**#41395** Flush Mount, Black Trim

## A4



### #41369P 4" LED Ceiling Light

- Dimmable
- Screw Mount
- Polycarbonate lens
- 316 Stainless Steel trim ring
- 16 x .5 W Warm White (4500K)
- 180 Lumens
- 12/24 V - 6 W
- IP-67

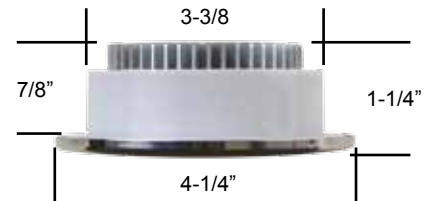

## A6



### #41370P 6" LED Ceiling Light

- Dimmable
- Screw Mount
- Polycarbonate lens
- 316 Stainless Steel trim ring
- 26 x .5 W Warm White (4500K)
- 545 Lumens
- 12/24 V - 9.3 W
- IP-67

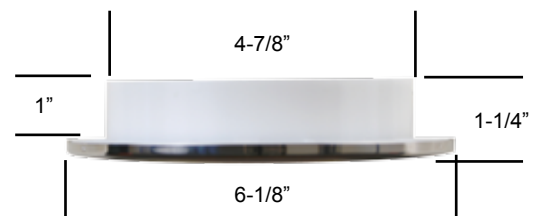

## Surface Mount Ceiling / Dome Lights

**NEW**

### LED Dual-Color Low-Profile Dome Light



#### #41461P LED Warm White / Blue

- 12/24 V - 6 W
- 30 LED Warm White (2900-3200K)
- 390 Lumens
- 26 LED Blue
- Plastic housing
- Surface mount
- IP65
- Touch Switch
- Switch glows Blue



#### #41462P LED Warm White / Red

- 12/24 V - 6 W
- 30 LED Warm White (2900-3200K)
- 390 Lumens
- 26 LED Red
- Plastic housing
- Surface mount
- IP65
- Touch Switch
- Switch glows Blue



#### #41340P LED ceiling light with switch

- 12V - 4.4W
- Dimmable when connected to an external dimming module (steady volt, non PWM)
- 24 x 0.2 Watt 2835 LEDs
- Warm White (2900-3200K)
- 328 Effective Lumens
- Plastic housing with high impact plastic lens
- Surface Mount
- IP66

**NEW**



#### #41323P

- 12/24 V
- 51 x 0.5 Watt 2835 LEDs
- Natural White (4500K)
- 720 Effective Lumens
- Plastic housing with high impact plastic lens
- Surface mount, 3 SS Screws Included
- IP67
- Three Stage Dimming Touch Switch
- Switch glows Blue

### LED Traditional SS Dome Light



#### #41324P LED 5-1/2" Dia. x 1-1/2" High

#### #41325P LED 6-3/4" Dia. x 1-5/8" High

- New LED version
- Stainless Steel
- Prismatic plastic lens
- Surface Mount

- 229 Lumens
- 12 V - 1.7 W
- 15° Beam Angle
- Side mounted on/off switch. Illuminated by 20 SMD 2835 warm white (4000K) LED's (compares with a 20 Watt Halogen bulb)

## Surface Mount Ceiling Lights

### LED 7" Oval Dome Light with Touch Switch



#### #41322P

- 12/24V
- 42 x 0.5 Watt 2835 LEDs
- Natural White (4500K)
- 680 Effective Lumens
- Plastic housing with high impact plastic lens
- Surface mount, 2 SS Screws Included
- IP67
- Three Stage Dimming Touch Switch
- Switch glows Blue

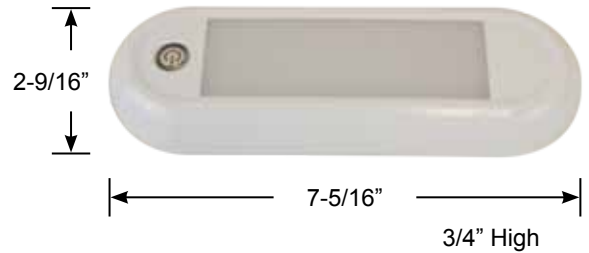

### LED 6" Rail Light with Motion Switch



#### #41465P

- 12/24V
- 22 x 0.2 Watt 2835 LEDs
- Color White
- 195 Effective Lumens
- Aluminum housing with high impact plastic lens
- Surface mount, 2 SS Screws included
- IP67
- Motion Switch

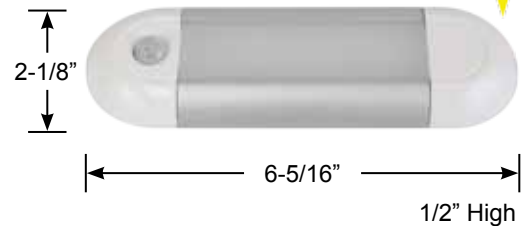

### LED 12" & 24" Rail Lights



#### #41466P 12"

- 12/24V
- 58 x 0.2 Watt 2835 LEDs
- Color White
- 550 Effective Lumens
- Aluminum housing with high impact plastic lens
- Surface mount, 2 SS Screws included
- IP67
- Without switch

#### #41467P 24"

- 118 x 0.2 Watt 2835 LEDs
- 820 Effective Lumens
- Other specifications the same as 12" rail light

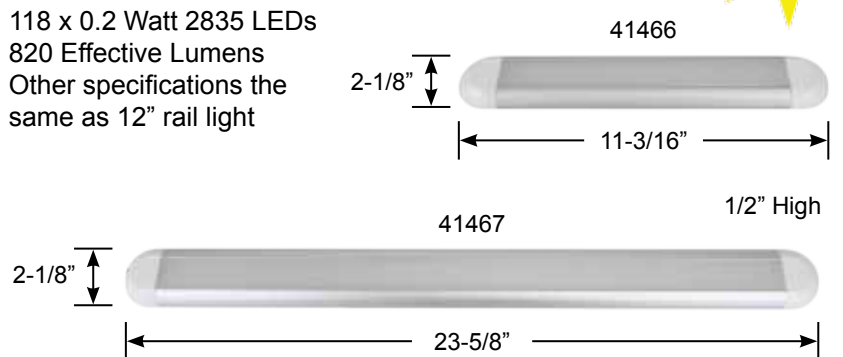

#### #41364P LED cabin light with switch

- Dimmable when connected to an external dimming module
- 12/24 V - 9 W
- 32 x 0.5 Watt Samsung 5630 LEDs
- Warm White (3000K)
- 535 Lumen
- Polycarbonate housing and diamond cut lens
- Surface Mount
- IP40 (for interior use)
- Dimensions: 13" L x 2-3/4" W x 7/8" H

## Cabin and Reading Lights



**#19052P** LED Polished Brass

- 12/24 V - 3.1 W
- Adjustable swivel light
- On/off rocker switch
- 16 SMD 2835 Warm White (2900-3200K) LED
- 154 Lumen
- 120° Beam Angle

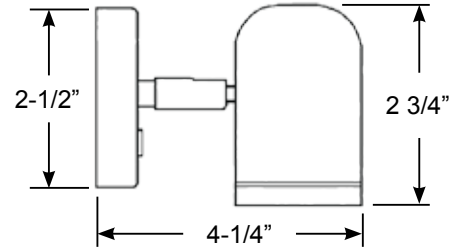

**#19053P** LED 304 Stainless Steel



**#41365** LED Frosted Glass Shade

- 12/24 V - 1.5 W
- Adjustable swivel light
- On/off rocker switch
- 304 Stainless Steel
- White frosted glass shade
- 0.12 A @ 12V, 0.06 A @ 24 V
- Warm White (2900-3200K) LED
- 290 Lumen
- 340° Beam Angle

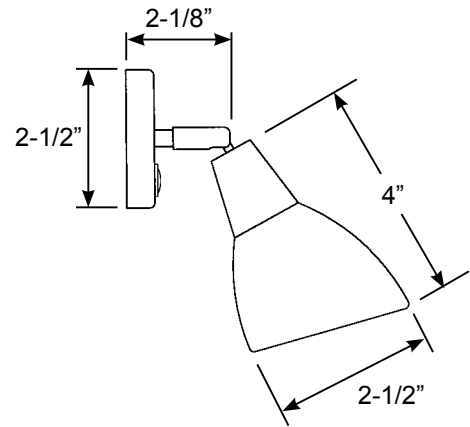

**#41330** with 12 V - 10 W Halogen bulb

**#41366** with **#41010** 12/24 V - 2 W Warm White (3000K) LED, 170 Lumens, back-pin wafer bulb

- Adjustable swivel light
- Chrome plated brass
- On/off rocker switch

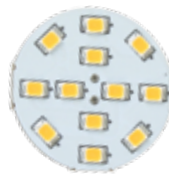

**#41010** LED back-pin wafer

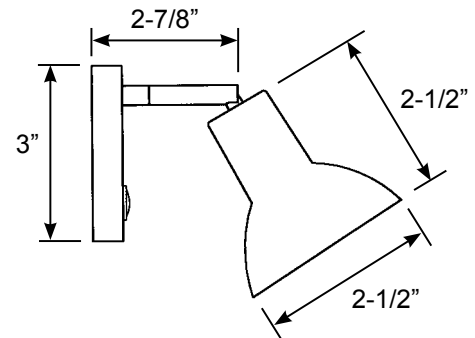

## Cabin and Reading Lights

---

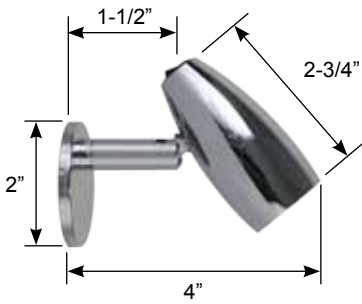

### #41396P LED Micro Reading Light

- Adjustable swivel light
- Chrome plated brass
- On/off rocker switch
- 12/24 V - 2.0 W
- 12 x 0.2 Watt LEDs
- Warm White (2,900-3,200K)
- 120 Lumen
- Beam Angle 120°
- LED Lifetime: 50,000 hours

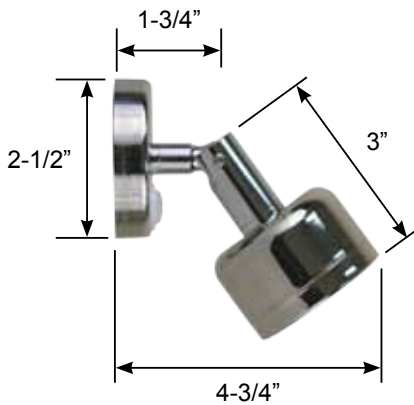

### #41397P LED Allure Reading Light

- Dimmable
- Adjustable swivel light
- 304 Stainless Steel
- On/off rocker switch
- 12/24 V - 3.1 W
- 1 x 3.0 Watt LED
- Warm White (2,850-3,200K)
- 160 - 140 Lumen
- Beam Angle 110°
- LED Lifetime: 50,000 hours



### #41336 LED Chart Light

- 12 V - 6 W
- 20-1/2" flexible arm
- 8 RED LEDs
- On/off rocker switch located on base
- Plastic base and LED housing with chrome spiral flexible arm

## Engine Room / Utility Lights



MARINE  
IGNITION  
PROTECTED



### #41590 E-330 LED Compact Engine Room Light

- 12/24 V - 10 W
- 33 x 0.5 Watt 2835 LEDs
- Cool White (5700-6300K)
- 727 Lumen
- Polycarbonate Lens with plastic housing
- Beam Angle: 120°
- Surface Mount (wire can exit from bottom or end of fixture)
- IP67

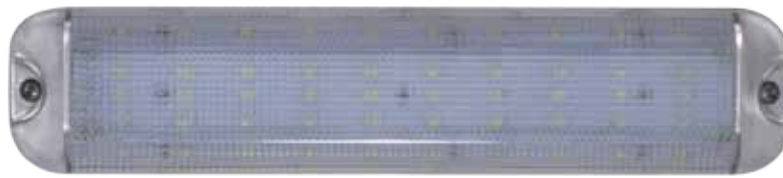
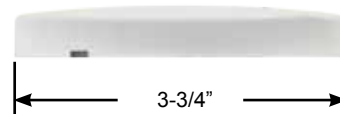
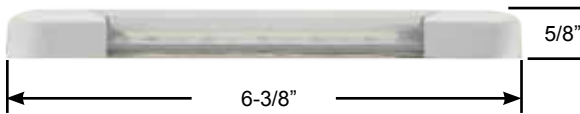
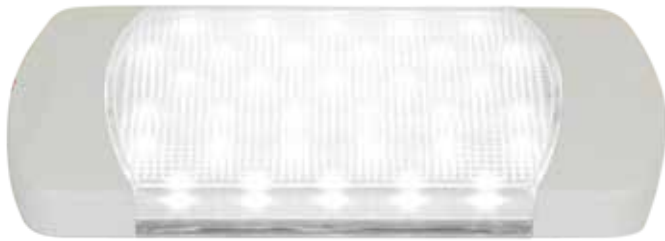

#41389

MARINE  
IGNITION  
PROTECTED



### #41388 E-360

- 12 V - 13.2 W  
LED Quantity: 36 (4 rows of 9 SMD2835 LEDs)  
Lumen: 1,154  
Protection: IP65

### #41389 E-500

- 12/24 V - 18 W  
LED Quantity: 50 (5 rows of 10 SMD2835 LEDs)  
Lumen: 1,520

- Protection: IP65  
LED Type: SMD5630 Cool White (5,500K-6,300K)  
Beam Angle: 120°  
Surface Mount (hardware included)  
Wire can exit from bottom or end of fixture  
Dimensions: 13" L x 2-3/4" W x 1" H

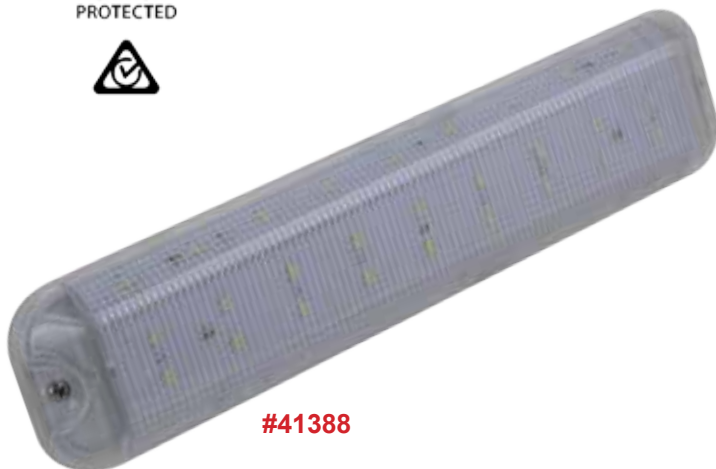

#41388



# Engine Room / Utility Lights

## #41593 E-1680 LED Engine Room / Utility Light

This super-bright, vibration resistant LED light meets the expectations of next generation vessels, refits or upgrades. The fixture can be powered by your DC battery system, AC generator/shore power or both. If connected to both, the PC board automatically switches to DC power, when AC power is lost. Meets the Requirements and Standards for SAE J1171. USCG. ABYC & NMMA. Includes trim ring for surface mount installation



- Flush or Surface Mount
- Single or dual voltage
- 30 Watt
- 168 Super-Bright 2835 LEDs
- Cool White (6000K)
- 3400 Lumen (similar to 2 x T8 fluorescent's)
- Beam Angle: 120°
- IP67
- Stainless Steel mounting hardware included
- 3-Year Warranty

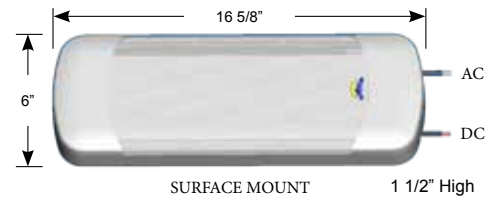
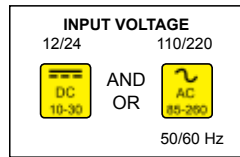

## LED Spreader / Deck Lights

**NEW**



### Bracket Mount Spreader Light

**#41440P White**

**#41441P Black**

Scandvik's LED Spreader Light is the perfect solution to illuminate your deck or cockpit. Featuring five, daylight white 3W LEDs providing 900 effective lumen output. A white Zytel® composite housing was designed specifically for the rigors of the marine environment. An adjustable stainless steel bracket mounting solution allows you to aim the light where it is needed most. Guaranteed against corrosion, discoloration and water intrusion. Comparable to a 120 watt incandescent bulb. Three year Manufacturers Warranty.

- 12/24 V - 12 W
- UV Resistant Zytel® Nylon Resin housing
- Polycarbonate Lens
- 900 Lumens
- IP68

### NEW Compact Size LED Spreader Light

- 12/24 V - 8.4 W
- High Quality Composition Frames
- Polycarbonate Lens
- UV Resistant
- Hidden Mounting Screws
- IP68
- Simple cutout for Flush Mount



**#41436 Flush Mount White**

**#41437 Flush Mount Black**

- 2 x 5 Watt Cree 3535 LEDs
- 500 Lumen
- 4" W x 2-1/2" H x 2" D
- Cutout: 2-3/4" W x 1-5/8" H



**#41435 Bracket Mount**

- 2 x 5 Watt Cree 3535 LEDs
- 500 Lumen
- 4-1/4" W x 2-5/8" H x 2-1/8" D



Installation Video



**#41343 Flush Mount with White Trim**

**#41356 Flush Mount with Black Trim**

### **NEW FLUSH MOUNT**

- 12/24 V - 12 W
- High Quality Composition Frame
- Polycarbonate Lens
- UV Resistant
- Hidden Mounting Screws
- Cool white LED color (5,500 - 6,300K)
- Temperature of LED: less than 158° with 77° ambient temperature
- Five 3 Watt Samsung 3535 LEDs
- 900 Lumens
- Equivalent to 120 Watt Halogen bulbs
- LED Lifetime: 50,000 Hours
- LED Beam angle: 110°
- 0.8 Amp draw at 12 Volt
- IP65
- Fits previous model cutout
- Dimensions: 6" W x 2-1/2" H x 1-3/4" D
- Cutout: 4-1/2" W x 1-1/2" H

## Underwater and Dock Lights

# U-12 Underwater LED Light

- #41430P White
- #41431P Blue
- #41432P Green



Installation Video



Thru-Hull Surface Mount  
Requires 3/8" (10mm) Hole



Standoff Block  
(Included)



Standoff Surface Mount  
(Does not require hole  
through transom)



- Copolyester (PCTG) Lens Housing
- 12 X SMD2835 (white & blue) Super Bright LEDs or 5mm High Flux green LEDs
- 414 Lumen (White)
- IP68
- 12 V
- White: 2.3 W, 0.2 A
- 20° Beam Angle provides intense illumination
- Mount with wire thru-hull or wire outside hull using included stand off mounting block
- 5' Cable / SS Screws Included
- Dimensions Thru-Hull Surface Mount: 3-3/8" W x 1-5/8" H x 7/8" D
- Dimensions Standoff Surface Mount: 3-3/8" W x 1-5/8" H x 1-1/4" D

**NEW**



### LED Solar Powered Dock Light

This Dock Light uses solar power to charge the battery during the daytime and turns on automatically at night. The number of hours the Dock Light illuminates depends on your geographical location, weather conditions and season. Mount lights 6 feet apart. SS wood screws included.

- Material:** Polycarbonate housing
- LED Color:** Cool White
- Solar Battery:** 2 V - 0.4 W
- Charge Battery:** NI-MH AAA 650mAH, 1.2 V
- Beam Angle:** 30°
- Operating Temperature:** -4° F ~ 122° F
- Protection:** IP67
- Dimensions:** 4" x 4"

- #41750
- #41750P 2-Pack

# Courtesy Lights

## Oval LED Courtesy Light with Blue Light

Small size surface mount 2-LED light with Polished 304 Stainless Steel trim. Suitable for interior or exterior installation. Stainless Steel mounting screws included.



- 12 V - 0.4 W
- 0.03 A
- Beam Angle 120°
- 5 Lumens
- IP67
- 1-11/16" W x 1" H x 3/8" D



#41460

## R-5

LED Courtesy lights with polished 316 Stainless Steel trim.

- 12 V - 0.4 W
- 0.03 Amp
- 5 x TOP LEDs
- Surface Mounted
- IP67
- 2-5/8" W x 13/16" H x 1/2" D



Side Illumination



Down Illumination

#41381 Daylight White Side Illumination, 15 Lumen

#41382 Blue Side Illumination, 3.5 Lumen

#41383 Daylight White Down Illumination, 15 Lumen

#41384 Blue Down Illumination, 3.5 Lumen

## O-5

LED surface mount courtesy light. ABS housing with white or stainless steel snap on trim. 5 x 0.4 Watt white LEDs (4,500K) or 5 TOP blue LED's. LED beam angle is 120°. White is 15 lumens and blue is 2.8 lumens. 12 V, IP65. Dimensions 2-7/8" L x 1-1/2" W x 7/16" D.



#41360 White LED with white trim

#41339 Blue LED with white trim

#41361 White LED with 316 Stainless Steel trim

#41362 Blue LED with 316 Stainless Steel trim

## #41371P LED Cockpit Light



- Surface Mount
- Polycarbonate housing and lens
- 5 x 0.5 W Warm White LED
- 128 Lumens
- 12 V - 2 W
- IP-67



## #41372P LED Cockpit Light



- Flush Mount
- Polycarbonate housing and lens
- 5 x 0.5 W Warm White LED
- 128 Lumens
- 12 V - 2 W
- IP-67



# SCAN-STRIP 4 - Color RGBW LED



16" RGBW SCAN-STRIP (30 LED)



8" RGBW SCAN-STRIP (15 LED)

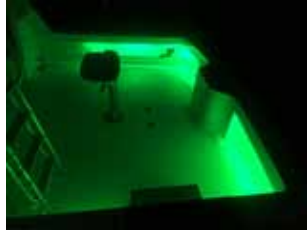
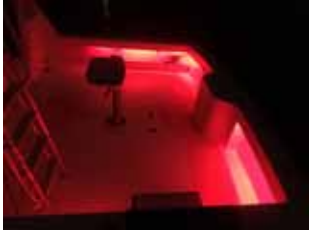
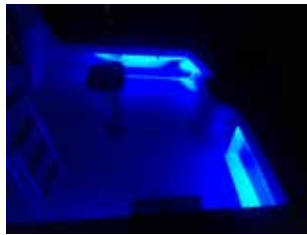
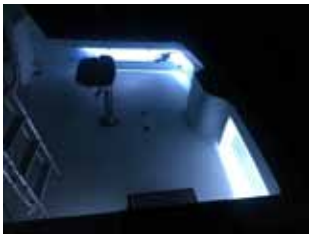

- RGBW LEDs
- Colors Daylight White (5500-6300K), Blue, Red, Green
- Lifespan 30,000 + Hours
- 120° Beam Angle
- 12/24 V (10-30VDC)
- Watts 8" = 1.2
- Watts 16" = 2.4
- Watts 20" = 3.1
- Lumens 8" White = 94
- Lumens 16" White = 180
- Lumens 20" White = 234
- IP65
- Ideal for under gunwale lighting
- SS Mounting Screws Included
- 1-year warranty
- 8" (8-7/8" L x 7/8" W x 1/2" H)
- 16" (16" L x 7/8" W x 1/2" H)
- 20" (20" L x 7/8" W x 1/2" H)

Scan-Strip 4-Color RGBW LED builds on the popularity of our original single color Scan-Strip LED. Simple 2-wire connections with any on/off switch is all that is required to cycle from White to Blue to Red to Green. Switch off for more than 4 seconds resets the color to white.

8" Scan-Strip 15 LEDs  
**#41650** RGBW

16" Scan-Strip 30 LEDs  
**#41651** RGBW

20" Scan-Strip 39 LEDs  
**#41652** RGBW

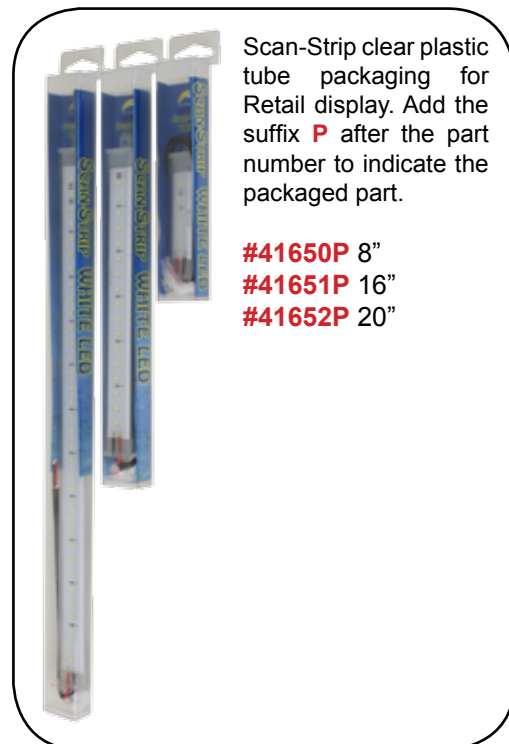

Scan-Strip clear plastic tube packaging for Retail display. Add the suffix **P** after the part number to indicate the packaged part.

- #41650P** 8"
- #41651P** 16"
- #41652P** 20"

# SCAN-STRIP LED



**4" SCAN-STRIP (5 LED)**



**8" SCAN-STRIP (17 LED)**



**16" SCAN-STRIP (34 LED)**



- NEW Super Bright 2835 LEDs
- Available in Cool White, Blue, Red and Green
- Lifespan 30,000 + Hours
- 120° Beam Angle
- 12 Volt
- Can be installed in engine rooms and exterior locations (IP65)
- Ideal for under gunwale lighting
- SS Mounting Screws Included
- 1-year warranty
- 4" (4" L x 7/8" W x 1/2" H)
- 8" (9" L x 7/8" W x 1/2" H)
- 16" (16-1/8" L x 7/8" W x 1/2" H)
- 36" (36" L x 7/8" W x 1/2" H)

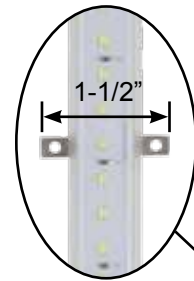

Middle support bracket

**36" SCAN-STRIP (85 LED)**

Scan-Strip LED lighting is a quality product for marine or RV use. Mount them almost anywhere, under gunwales, in storage lockers, coolers, fish boxes, engine rooms. Use below deck in cabin areas for general lighting or courtesy lights.

Scan-Strip clear plastic tube packaging for Retail display. Add the suffix **P** after the part number to indicate the packaged part.

- #41354P** 4" White
- #41357P** 4" Blue
- #41346P** 8" White
- #41347P** 8" Blue
- #41350P** 16" White
- #41351P** 16" Blue
- #41358P** 36" White
- #41359P** 36" Blue

MARINE  
IGNITION  
PROTECTED



4" Scan-Strip 5 LEDs  
**#41354** White (5,500K)  
**#41357** Blue

8" Scan-Strip 17 LEDs  
**#41346** White (5,500K)  
**#41347** Blue

16" Scan-Strip 34 LEDs  
**#41350** White (5,500K)  
**#41351** Blue

36" Scan-Strip 85 LEDs  
**#41358** White (5,500K)  
**#41359** Blue

images are  
not to scale

# LED Flex-Strips

## 12mm Wide Single Color



Thicker durable strip with no adhesive backing. 30 or 60 LED's per meter. 5-meter (16') reels wired at both ends, can be cut to custom lengths. 24 silicone mounting clips and 2 end caps included.

\*Dimmable with optional controller.

Part Number	Color	LED's per meter	Length	Width	Voltage	Dimmable	Protection
41510	Warm White	60	16' (5-meter)	12mm	12 V	Yes*	IP68
41511	Cool White	60	16' (5-meter)	12mm	12 V	Yes*	IP68
41520	Red	30	16' (5-meter)	12mm	12 V	Yes*	IP68
41521	Blue	30	16' (5-meter)	12mm	12 V	Yes*	IP68
41522	Green	30	16' (5-meter)	12mm	12 V	Yes*	IP68
41523	Blue	60	16' (5-meter)	12mm	12 V	Yes*	IP68

## 14mm Wide Dual Color



### TWO COLORS IN ONE STRIP!

Strips can be cut on the cut-marks and sealed with silicone end caps and installed with silicone clips included. Strips can be wired together to make longer runs.

- Wired on both ends
- IP68
- SMD5050 LEDs
- 60 LED/meter
- Blue/Red or Cool White or both together
- 14mm wide
- Requires a double throw (on/off/on) switch



Short Length Kit Retail Package



Optional mounting with 41731 14mm Flex-Trak

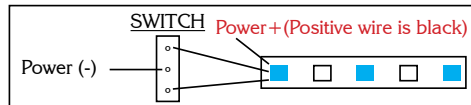

Part Number	Color	Length	Width	Voltage	Dimmable	Protection
41524	Blue-White	16' (5-meter)	14mm	12 V	Yes*	IP68
41525	Red-White	16' (5-meter)	14mm	12 V	Yes*	IP68
41514	Blue-White	21"	14mm	12 V	Yes*	IP68
41515	Red-White	21"	14mm	12 V	Yes*	IP68
41516	Blue-White	48"	14mm	12 V	Yes*	IP68
41517	Red-White	48"	14mm	12 V	Yes*	IP68



## RGB Modules

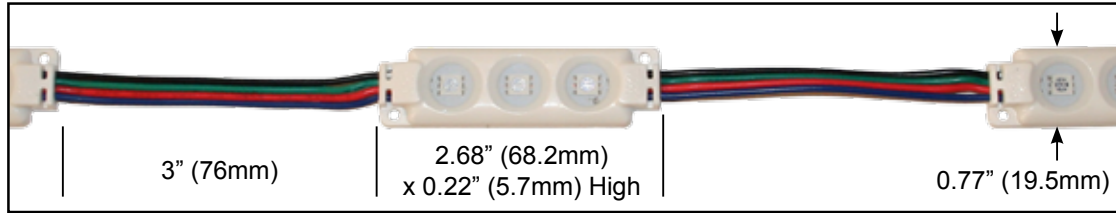

- Weatherproof Rated IP67
- Shorten length by cutting the four wires between modules
- Lengthen by attaching up to four 20 module lengths together.
- Injection molded housing - Aluminum PCB with full resin sealant
- Three High intensity SMD5050 RGB LED, including Bright White illumination, in each module
- Modules: 0.72 W each
- Twenty RGB LED Module String: 14.4 W - 1.20 A
- Screw hole mounting tabs molded into each module.

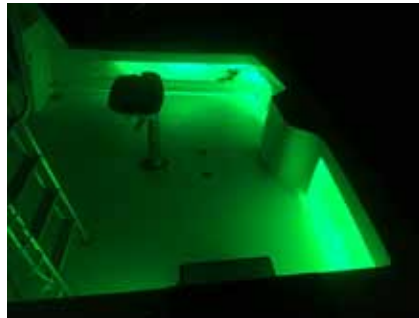

Part #	Description	Length	Voltage	Controller
<b>41580</b>	20 Module String	9'-3"	12 V	
<b>41581</b>	20 Module String with controller and 10M RGB wire	9'-3"	12 V	41606
<b>41582</b>	Two 20 Module Strings with (41606) controller with Rainbow Touch remote and (19061) 10M RGB wire	18'-6"	12 V	41606
<b>41583</b>	20 Module String with (41599) 4-color controller and (19061) 10M RGB wire	9'-3"	12 V	41599
<b>41584</b>	Two 20 Module Strings with (41599) 4-color controller and (19061) 10M RGB wire	18'-6"	12 V	41599

## Accessories

### #41599 LED RGB 4-Color Controller

- Works with any RGB LED Material
- Cycles through: White/Blue/Red/Green with any switch
- 4-Second Reset to White
- 12/24 V - 60 W
- IP67

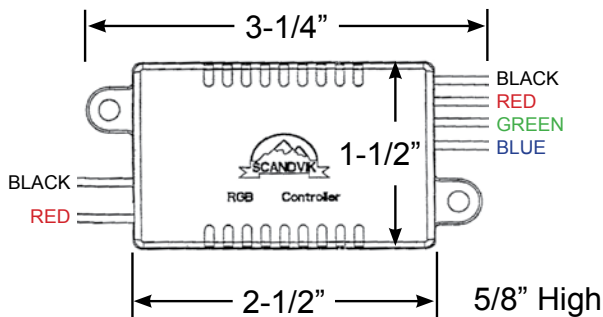

### #41606 RF RGB Controller with Rainbow-Touch Remote

#### #41615 Rainbow-Touch Remote ONLY

The RGB RF Wireless remote control utilizes an advance microprocessor control unit allowing the user to turn the LED Flex-Strip on and off, adjust the color, brightness and dimming and selecting one of 15 programmed lighting modes including flashing, fading and color jump.

- Works with any RGB material
- Technical parameters (controller):
- Input voltage: 12V
- Output control: 3 Circuits (Red, Green, Blue)
- Output Current: 6 A per circuit - 18 total Amps
- Output Power: 72 W per circuit - 216 total Watts
- Operating Temp: -4°F to 140°F
- Rainbow-Touch RF Remote:
- Power Supply: (2) AAA Batteries (Not Included)
- Material: ABS - UV Protected
- Transmit Range: Up to 60 Feet

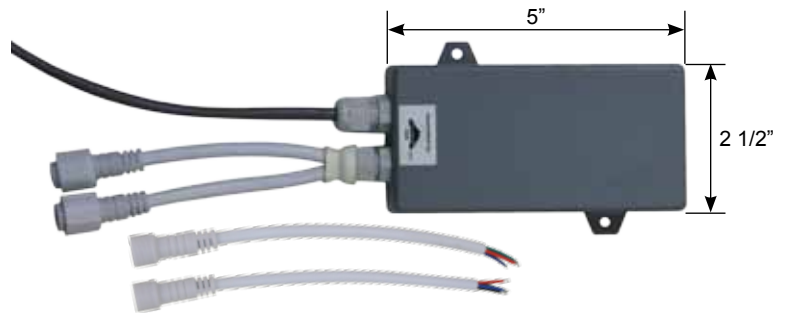
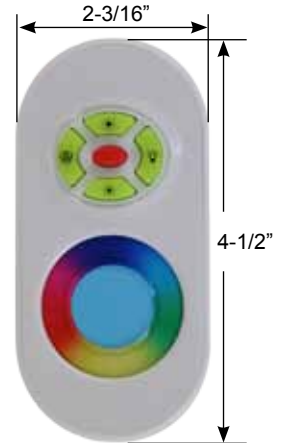

## LED RGB ACCESSORIES

### #19061 10 Meter RGB 20 AWG wire



#41608 Weather proof LED power amplifier. Use between RGBW strings.  
Power: 12V, 4 A per channel  
Input & Output: RGBW channels

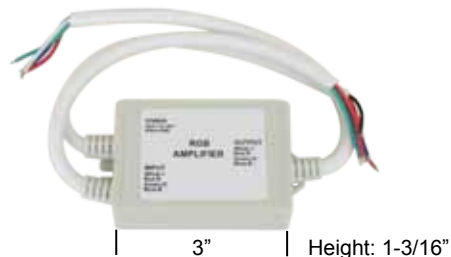

# Flex-Strip Accessories



**#41600** 12mm Silicone End Caps  
**#41602** 14mm Silicone End Caps



**#41601** 12mm Silicone Mounting Clips  
**#41603** 14mm Silicone Mounting Clips



**#41607** Wall Mount 12V Dimmer with IR Remote



## FLEX-TRAK

Flex-Trak plastic channel for 12mm and 14mm Flex-Strips  
 Flexible, easily cut to length, pre-drilled, mounting with #4 countersunk screws or double stick tape. Length: 4'.

**#41730** 12mm  
**#41731** 14mm



## WATERPROOF ELECTRONIC LED DRIVER POWER SUPPLIES

All are 12 V Output, IP67, UL Rated

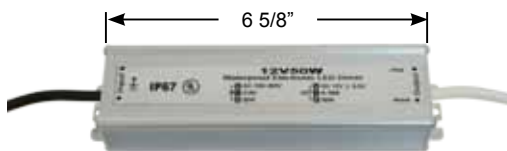

**#41610**

50 W  
 Input: AC 100~265 V - 0.4 A  
 Output: DC 12V - 4.16 A  
 Shipping Weight: 2 lbs.

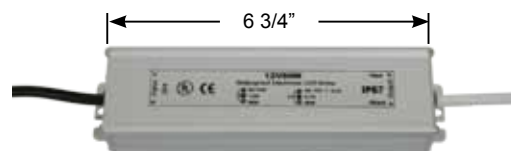

**#41611**

80 W  
 Input: AC 110 V - 1.0 A  
 Output: DC 12 V - 6.7 A  
 Shipping Weight: 2 lbs.

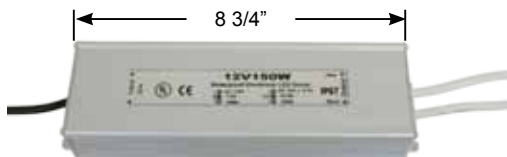

**#41612**

150 W  
 Input: AC 110 V - 1.6 A  
 Output: DC 12 V - 12.5 A  
 Shipping Weight: 3 lbs.



**#41613**

250 W  
 Input: AC 110 ~ 250 V - 1.2 A  
 Output: DC 12 V - 20  
 Shipping Weight: 3 lbs.



# LED Replacement Bulbs



- Replacement LED in clamshell with information and sell sheet
- Replacements for popular G4, Bayonet, Wedge and Festoon base types
- Available colors: Warm White, Cool White, BLUE, RED, White/BLUE and White/RED
- More than 60% more efficient than incandescent bulbs (very low amp draw)
- Lower temperature than incandescent bulbs

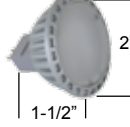

## You Have

## You Need

 20 W Halogen	<b>MR16 LED</b> <b>41008P</b> Warm White <b>41009P</b> Cool White Lumen: 290 WW Lumen: 320 CW	Volts: 12/24 VDC and 12 VAC Amps: 0.42 @ 12 V 0.21 @ 24 V Watts: 5 Beam Angle: 120° Dimmable: Yes	 2" 1-1/2"
 20 W Halogen	<b>GU10 LED</b> <b>41114P</b> Warm White <b>41115P</b> Cool White Lumen: 290 WW Lumen: 320 CW	Volts: 120VAC Amps: 0.1 Watts: 5 Beam Angle: 120° Dimmable: Yes	 2" 2-3/16"

## You Have

## You Need

 20 W Halogen	<b>G4 Wafer Side-Pin DUAL Color</b> Volts: 12/24 Lumen: 150 WW, 180 CW Amps: 0.14 @ 12 V (White) Watts: 1.7 White, 0.5 Color <b>41050P</b> Warm White / Blue <b>41051P</b> Warm White / Red <b>41052P</b> Cool White / Blue <b>41053P</b> Cool / Red	 1-3/4"
---	--	---

 10 W Halogen	<b>G4 Wafer Back-Pin</b> Volts: 12/24 Lumen: 120 WW, 140 CW Amps: 0.12 @ 12 V, Watts: 1.5 Beam Angle: 120° Dimmable: Yes <b>41000P</b> Warm White <b>41001P</b> Cool White	 7/8"
---	---	---

 20 W Halogen	<b>G4 Tower</b> Volts: 12/24 Lumen: 220 WW, 260 CW Amps: 0.21 @ 12 V Watts: 2.5 Beam Angle: 270° Dimmable: Yes <b>41070P</b> Warm White <b>41071P</b> Cool White	 7/8" 1-3/8" 2-1/8"
---	--	---

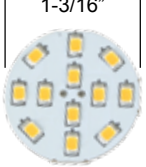

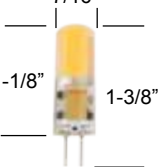
 20 W Halogen	<b>G4 Wafer Back-Pin</b> Volts: 12/24 Lumen: 170 WW, 190 CW Amps: 0.17 @ 12 V, Watts: 2.0 Beam Angle: 120° Dimmable: Yes <b>41010P</b> Warm White <b>41011P</b> Cool White	 1-3/16"
---	---	--

 20 W Halogen	<b>G4 Halogen Look-Alike</b> Volts: 12/24 Lumen: 180 WW, 210 CW Amps: 0.21 @ 12 V Watts: 1.5 Beam Angle: 270° Dimmable: No <b>41072P</b> Warm White <b>41073P</b> Cool White	 7/16" 1-1/8" 1-3/8"
---	--	--

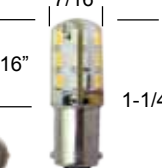

 10 W Halogen	<b>G4 Wafer Side-Pin</b> Volts: 12/24 Lumen: 120 WW, 140 CW Amps: 0.12 @ 12 V Watts: 1.5 White, 1.0 Color <b>41020P</b> Warm White <b>41021P</b> Cool White <b>41022P</b> Blue <b>41023P</b> Red	 7/8" 7/8" WW / CW Blue / Red
---	--	--

 53 or 57	<b>Mini-Bayonet, Mini-Tower</b> Parallel Pins - Single Contact Volts: 12/24 V Base: BA9s Lumen: 100 Amps: 0.12 @ 12 V Watts: 1.5 <b>41075P</b> Warm White	 7/16" 11/16" 1-1/4"
---	--	--

 20 W Halogen	<b>G4 Wafer Side-Pin</b> Volts: 12/24 Lumen: 170 WW, 190 CW Amps: 0.17 @ 12 V Watts: 2.0 <b>41030P</b> Warm White <b>41031P</b> Cool White <b>41032P</b> Blue <b>41033P</b> Red	 1-3/16" 1-3/16" WW / CW Blue / Red
---	---	--

 10 W Halogen	<b>Bayonet Mini-Tower</b> Volts: 12/24 V Base: BA15s Lumen: 170 Amps: 0.16 @ 12V Watts: 1.9 Beam Angle: 270° <b>41034P</b> Warm White	 5/8" 3/4" 1-1/2"
---	--	---

 20 W Halogen	<b>G4 Wafer Side-Pin</b> Volts: 12/24 Lumen: 270 WW, 310 CW Amps: 0.25 @ 12 V Watts: 3.0 Beam Angle: 120° Dimmable: Yes <b>41040P</b> Warm White <b>41041P</b> Cool White	 1-3/8"
---	---	---

 1142 or 1176	<b>Bayonet Tower</b> Parallel Pins - Dual Contacts Volts: 12/24 V Base: BA15d Lumen: 190 WW, 220 CW Amps: 0.21 @ 12 V Watts: 3.0 <b>41080P</b> Warm White <b>41081P</b> Cool White	 5/8" 1-1/16" 1-13/16"
---	--	--

# LED Replacement Bulbs

**You Have**

**You Need**

**Bayonet Tower  
Offset Pins - Dual Contacts** **NEW** | 5/8" |  
Volts: 12/24 V  
Base: BAY15d  
Lumen: 190 WW, 220 CW  
Amps: 0.21 @ 12 V  
Watts: 3.0  
41082P Warm White  
41083P Cool White

**You Have**

**You Need**

**Wedge Base**  
Volts: 12/24 V  
Base: T10 Wedge  
Lumen: 180  
Amps: 0.13 @ 12 V  
Watts: 1.5  
41097P Warm White

**Bayonet Compact-Tower  
Parallel Pins - Single Contact** **NEW** | 5/8" |  
Volts: 12/24 V  
Base: BA15s  
Lumen: 190 WW, 220 CW  
Amps: 0.21 @ 12 V  
Watts: 3.0  
41084P Warm White  
41085P Cool White

**Festoon 360°**  
Base: 30mm Festoon  
Lumen: 115  
Volts: **12V ONLY**  
Amps: 0.1  
Watts: 1.2  
Beam Angle: 360°  
41035 Warm White

**Bayonet Base Wafer  
Parallel Pins - Dual Contacts**  
Volts: 12/24 V  
Base: BA15d  
Lumen: 55 WW, 65 CW  
Amps: 0.06 @ 12 V  
Watts: 0.7  
41086P Warm White  
41087P Cool White

**Festoon Wafer**  
Volts: 12/24 V  
Base: 31mm Festoon  
Lumen: 45 WW, 65 CW  
Amps: 0.06 @ 12 V  
Watts: 0.7  
41100P Warm White  
41101P Cool White

**Bayonet Base Wafer  
Offset Pins - Dual Contacts**  
Volts: 12/24 V  
Base: BAY15d  
Lumen: 55 WW, 65 CW  
Amps: 0.06 @ 12 V  
Watts: 0.7  
41088P Warm White  
41089P Cool White

**Festoon Wafer 37/42mm**  
Volts: 12/24 V  
Base: 37mm and 42mm Festoon  
Lumen: 75 WW, 90 CW  
Amps: 0.10 @ 12 V, Watts: 1.2  
41102P 37mm Warm White  
41103P 37mm Cool White  
41104P 42mm Warm White  
41105P 42mm Cool White

**Bayonet Base Mini-Tower**  
Volts: 12/24 V  
Base: BA15d  
Lumen: 170  
Amps: 0.16 @ 12 V  
Watts: 1.9  
Beam Angle: 270°  
41090P Warm White

**Festoon Wafer**  
Volts: 12/24 V  
Base: 42mm Festoon  
Lumen: 140 WW, 160 CW  
Amps: 0.17 @ 12 V  
Watts: 2.0  
41106P Warm White  
41107P Cool White

**Wedge Base Tower**  
Volts: 12/24 V  
Base: T10 Wedge  
Lumen: 220  
Amps: 0.21 @ 12 V  
Watts: 2.5  
Beam Angle: 270°  
Dimmable: Yes  
41092P Warm White

**360° Nav. Festoon**  
Volts: 12/24 V  
Base: 42mm Festoon  
Lumen: 175 WW, 210 CW  
Amps: 0.21 @ 12 V  
Watts: 2.5  
41110P Warm White  
41111P Cool White

**Wedge Base Mini-Tower**  
Volts: 12/24 V  
Base: T10 Wedge  
Lumen: 75  
Amps: 0.06  
Watts: 0.8  
41095P Warm White

**360° Nav. Barrel**  
Volts: 12/24 V  
Base: 43mm Barrel  
Lumen: 175 WW, 210 CW  
Amps: 0.21 @ 12 V  
Watts: 2.5  
41112P Warm White  
41113P Cool White

# LED Replacement Bulbs

**You Have**

**You Need**



**A15 Style Bulb**  
**Volts:** 12/24 V  
**Base:** E27  
**Lumen:** 270  
**Amps:** 0.25 @ 12V  
**Watts:** 3.0  
**Beam Angle:** 150°  
**41036P** Warm White

**NEW**



1-7/8"  
3"



**A19 Style Bulb**  
**Volts:** 12/24 V  
**Base:** E27  
**Lumen:** 450  
**Amps:** 0.46 @ 12V  
**Watts:** 5.5  
**Beam Angle:** 120°  
**41037P** Warm White

**NEW**



2-1/4"  
4"

**G4 Base Adapters**

**BA15d to G4**  
 Swivels up to 120°  
**41120P**

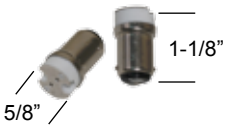

5/8"  
1-1/8"

**BA15s to G4**  
 Swivels up to 120°  
**41121P**



5/8"  
1-1/8"

**E27 to G4**  
 Standard Household Edison Socket  
**41122P**



1-5/8"  
1-1/8"  
5/8"

## Retail LED Replacement Bulb/Strip Displays

**#41140** Small Display Bulbs/Strips

**#41144** Small Display Bulbs Only

Overall Dimensions: 30"H x 11"W x 10"D



41140 Qty.	41144 Qty.	SKU	Description
	1	41000P	G4 Back-Pin Wafer 9 LEDs WW
1	1	41010P	G4 Back-Pin Wafer 12 LEDs WW
1	1	41020P	G4 Side-Pin Wafer 9 LEDs WW
1	1	41030P	G4 Side-Pin Wafer 12 LEDs WW
1	1	41032P	G4 Side-Pin Wafer 10 LEDs BLUE
1		41033P	G4 Side-Pin Wafer 10 LEDs RED
1	1	41040P	G4 Side-Pin Wafer 21 LEDs WW
	1	41052P	G4 Side-Pin Wafer 12/3 LEDs COOL WHITE/BLUE
1	1	41070P	G4 Bottom-Pin Compact Tower 18 LEDs WW
1	1	41072P	G4 Bottom-Pin LED WW
	1	41075P	BA9s Mini Tower 5 LEDs WW
	1	41080P	BA15d Tower 18 LEDs WW
	1	41082P	BAY15d Tower 18 LEDs WW
	1	41084P	BA15s Tower 18 LEDs WW
	1	41086P	BA15d Wafer 4 LEDs WW
	1	41090P	BA15d Mini Tower 8 LEDs WW
	1	41095P	T10 Wedge Mini Tower 5 LEDs WW
1	1	41097P	T10 Wedge LED Optic Lens WW
	1	41100P	31mm Festoon 4 LEDs WW
	1	41102P	37mm Festoon 6 LEDs WW
	1	41104P	42mm Festoon 6 LEDs WW
1	1	41106P	42mm Festoon 9 LEDs WW
1	1	41120P	Adapter: BA15d to G4
1	1	41121P	Adapter: BA15s to G4
	1	41122P	Adapter: E27 to G4
1		41346P	8" Scan-Strip WHITE
1		41347P	8" Scan-Strip BLUE
1		41514P	21" DUAL Color COOL WHITE/BLUE
1		41515P	21" DUAL Color COOL WHITE/RED



# Retail LED Replacement Bulb/Strip Displays

- #41141** Large Display Bulbs/Strips
- #41142** Full Large Display Bulbs/Strips
- #41145** Large Display Bulbs Only
- #41146** Full Large Display Bulbs Only

Overall Dimensions: 32"H x 14"W x 10"D

41141	41142	41145	41146	SKU	Description
2	4	4	8	41000P	G4 Back-Pin Wafer 9 LEDs WW
2	2	4	6	41008P	MR16 5 Watt LEDs WW
2	4	4	8	41010P	G4 Back-Pin Wafer 12 LEDs WW
2	5	4	10	41020P	G4 Side-Pin Wafer 9 LEDs WW
4	10	4	10	41030P	G4 Side-Pin Wafer 12 LEDs WW
2	5	2	5	41032P	G4 Side-Pin Wafer 10 LEDs BLUE
2	5	2	5	41033P	G4 Side-Pin Wafer 10 LEDs RED
4	10	4	10	41040P	G4 Side-Pin Wafer 21 LEDs WW
2	5	2	5	41052P	G4 Side-Pin Wafer 12/3 LEDs COOL WHITE/BLUE
2	3	2	4	41070P	G4 Bottom-Pin Compact Tower 18 LEDs WW
2	5	4	10	41072P	G4 Bottom-Pin LED WW
2	5	2	5	41075P	BA9s Mini Tower 5 LEDs WW
2	3	2	4	41080P	BA15d Tower 18 LEDs WW
2	3	2	4	41082P	BAY15d Tower 18 LEDs WW
2	3	2	4	41084P	BA15s Tower 18 LEDs WW
		2	5	41086P	BA15d Wafer 4 LEDs WW
		2	5	41088P	BAY15d Wafer 4 LEDs WW
2	5	4	10	41090P	BA15d Mini Tower 8 LEDs WW
2	3	2	4	41092P	T10 Wedge Compact Tower 18 LEDs WW
2	5	2	5	41095P	T10 Wedge Tower 5 LEDs WW
2	5	2	5	41097P	T10 Wedge LED Optic Lens WW
		4	10	41100P	31mm Festoon 4 LEDs WW
		2	5	41102P	37mm Festoon 6 LEDs WW
		2	5	41104P	42mm Festoon 6 LEDs WW
2	5	4	10	41106P	42mm Festoon 9 LEDs WW
4	10	4	10	41120P	Adapter: BA15d to G4
2	5	2	5	41121P	Adapter: BA15s to G4
2	3	2	4	41122P	Adapter: E27 to G4
2	4			41346P	8" Scan-Strip WHITE
2	4			41347P	8" Scan-Strip BLUE
2	4			41350P	16" Scan-Strip WHITE
2	4			41351P	16" Scan-Strip BLUE



**#13001**  
23" x 17" Padded counter mat displaying the LED light bulb replacement program. Both original incandescent and replacement LED bulbs are displayed in actual size.



SCANDVIK LIGHTING

Scandvik, Inc.  
423 4th Place S.W.  
Vero Beach, FL 32962

Tel. 772-567-2877 Fax. 772-567-9113  
[www.scandvik.com](http://www.scandvik.com)